

# AQUATIC AV®

products with a watertight reputation

## BLUECUBE - AQ-BC-5BT WATERPROOF MEDIA PLAYER

for Bluetooth MP3 devices

### OWNERS MANUAL

 **BLUECUBE**  
MEDIA PLAYER



! PLEASE READ THIS INSTRUCTION MANUAL BEFORE  
INSTALLATION AND OPERATION !

<b>1 Getting Started</b> .....	<b>3</b>
1.1 Contents.....	3
1.2 Connections.....	3
1.3 12-pin Harness Connection.....	4
1.4 Mounting the BlueCube Media Player.....	4
1.5 Power On.....	5
1.6 Handheld Remote Control Battery Install.....	5
1.7 Handheld Remote Control Synchronizing.....	5
<b>2 Location of Controls</b> .....	<b>6</b>
2.1 Wireless Handheld Remote Control.....	6
2.2 Wired Remote Control.....	6
<b>3 Listening to Devices</b> .....	<b>7</b>
3.1 Listening via Bluetooth.....	7
3.1.1 Pair with Bluetooth Device.....	7
3.1.2 Listening via Bluetooth Device.....	7
3.2 Listening via Auxiliary Input.....	7
3.3 Adjust Volume Level.....	7
<b>4 Specifications &amp; Dimensions</b> .....	<b>8</b>
4.1 Specifications.....	8
4.2 Dimensions.....	8
<b>5 Warranty Information</b> .....	<b>9</b>

## 1.1 Contents

- AQ-BC-5BT BlueCube Media Player
- Wiring Harness (AQ-UNH-2)
- Four (4) Stainless Steel Mounting Screws
- Owner's Manual

## 1.2 Connections

### 1. 12-pin Watertight Harness

The 12-pin harness supplies power and ground connections to the BlueCube Media Player and four (4) speaker channel output connections from the BlueCube Media Player.

 *Do not cut or modify the 12-pin harness on the unit side or warranty will be void.*

### 2. Auxiliary Outputs

Allows external amplifiers to be connected to power additional speakers.

### 3. Auxiliary Inputs

Connect to a portable audio player through the AUX IN cable on the back of the Digital Media Box.

### 4. Wired Remote 8-pin DIN Cable

Connect to optional wired Remote Control (sold separately).

### 5. Wireless Remote RF Receiver 8-pin DIN Cable

Connect to optional wireless handheld Remote Control (sold separately).

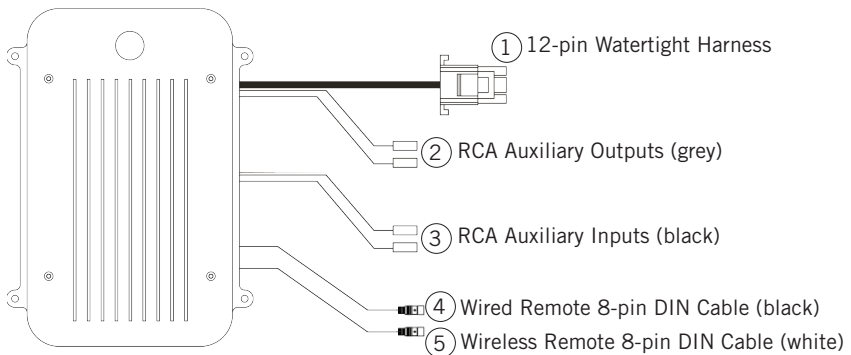

## 1.3 12-pin Harness Connection

The AQ-BC-5BT includes the universal harness AQ-UNH-2 in order to connect the BlueCube to power and speakers.

All open wire connections should be soldered and protected against water and dust for best long term performance.

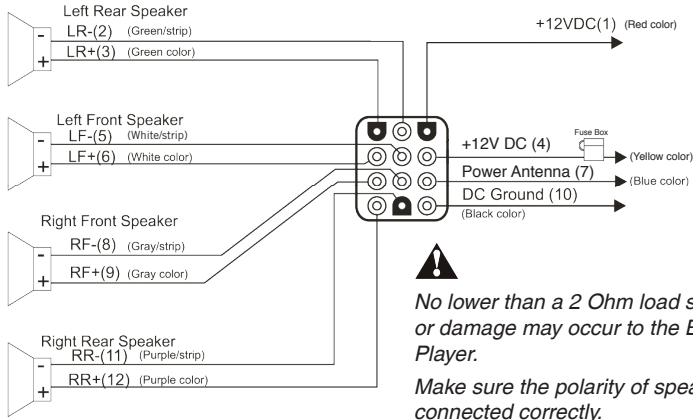

## 1.4 Mounting the BlueCube Media Player

1. Make sure the outside surface is clean and clear of debris.
2. The BlueCube Media Player has four (4) front screws. Drive the screws using a screw driver. Make sure screws are snug and do not over tighten.

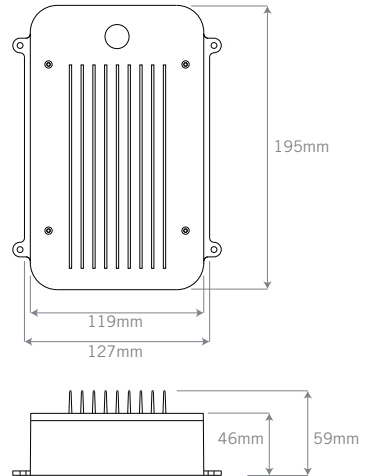

## 1.5 Power On

The AQ-BC-5BT requires +12V DC to both the red and yellow wires. When both of these wires have power the AQ-BC-5BT is always powered on and is indicated by a red LED coming out of the heatsink of the stereo. Ground is connected to the Black wire.

In a spa application this requires the red and yellow wires to be jumped together and then connected to the +12VDC output of the power source. In this set up the AQ-BC-5BT will always be on, with a very low current draw when idle.

In a boat, ATV or other application requiring power from a battery, the yellow wire (constant power) should be connected to the battery, and the red wire connected to the ignition or a switch.

For detailed instructions you can check out our online video:

‘How to wire your Aquatic AV stereo system’  
<http://www.aquaticav.com/support/videos>



## 1.6 Handheld Remote Control Battery Install (AQ-RFBC-5BT sold separately)

Unscrew the waterproof cap on the back of the remote control. Place the CR-2430 battery in the RF remote control and replace the water/dust proof cap.

When the battery is installed, the remote control LCD should be solid and bright without any flickering.

## 1.7 Handheld Remote Control Synchronizing (AQ-RFBC-5BT sold separately)

The remote should already be paired from the factory, but if you need to re synchronize the remote follow the steps below.

1. Press the  POWER button on the remote control to turn on the remote.
2. The LCD will become illuminated and read ‘NO LINK’.
3. Press and hold the  MODE button for 5 – 10 seconds.
4. Once the remote has been paired, the LCD will display one of the audio modes (BT AUDIO or AUX).

For any additional remote controls, you will also need to activate/synchronize those remote controls by following the steps above.





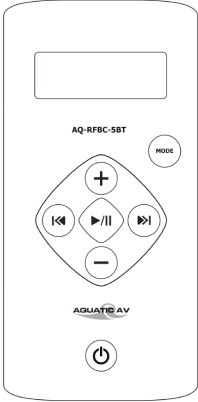

 *If the pairing process is not effective, check the battery voltage of the remote. If above 3V DC refer to section 1.5 above to make sure the battery is installed correctly. If battery voltage is below 3V DC replace the battery.*

 *If the LCD displays “NO LINK” in any mode, this means the remote is out of reception range or not paired correctly. Move the remote closer to the unit and try again.*

 *If you lose your remote control and buy a new remote control, please follow the above to pair remote control.*







## 2.1 Wireless Handheld Remote Control AQ-RFBC-5BT (sold separately)

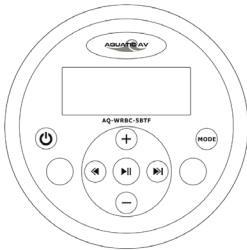

Buttons	AUX IN Mode	Bluetooth Mode
Power	 Press once: Toggle from Operation mode to Standby mode or vice-versa.	
Mode	 Press once: Change the source. Press and hold: Pair	Press once: Change the source. Press and hold: Pair
Volume Up	 Press once: Volume up Press and hold: Fast volume up	Press once: Volume up Press and hold: Fast volume up
Volume Down	 Press once: Volume down Press and hold: Fast volume down	Press once: Volume down Press and hold: Fast volume down
Fast Rewind	 Press once: no function Press and hold: no function	Press once: Previous track Press and hold: Previous track
Fast Forward	 Press once: no function Press and hold: no function	Press once: Next track Press and hold: Next track
Play/pause	 Press once: Toggle Mute Press and hold: Toggle Mute	Press once: Play/Pause Press and hold: Play/Pause

## 2.2 Wired Remote Control AQ-WRBC-5BT (sold separately)



Buttons	AUX IN Mode	Bluetooth Mode
Power	 Press once: Toggle from Operation mode to Standby mode or vice-versa.	
Mode	 Press once: Change the source.	Press once: Change the source.
Volume Up	 Press once: Volume up Press and hold: Fast volume up	Press once: Volume up Press and hold: Fast volume up
Volume Down	 Press once: Volume down Press and hold: Fast volume down	Press once: Volume down Press and hold: Fast volume down
Fast Rewind	 Press once: no function Press and hold: no function	Press once: Previous track Press and hold: Previous track
Fast Forward	 Press once: no function Press and hold: no function	Press once: Next track Press and hold: Next track
Play/pause	 Press once: Toggle Mute Press and hold: Toggle Mute	Press once: Play/Pause Press and hold: Play/Pause



## 3.1 Listening via Bluetooth

### 3.1.1 Pair with Bluetooth Device

1. Switch on your Bluetooth device.
2. Select 'AQUATIC AV' from the list of available devices to pair (no password is needed).

**i** Only one Bluetooth device can be paired with the BlueCube Media Player at any time.

### 3.1.2 Listening via Bluetooth Device





1. Bluetooth mode will be activated once a Bluetooth device is paired.
2. Play the song from device and the sound will play through the BlueCube Media Player.
3. Press  (PLAY/PAUSE) to play/pause the song.
4. Press  /  (FAST REWIND/FORWARD) buttons to play previous/next song file.
5. Track and volume can be controlled directly from your Bluetooth device or remote control.

## 3.2 Listening via Auxiliary Input

1. Connect your MP3 device to the RCA inputs.
2. Press  (MODE) on the remote control to select 'AUX IN' mode.

**i** Only one Auxiliary input (RCA) can be used at any one time.

## 3.3 Adjust Volume Level

1. Press  (VOLUME UP) once to increase the volume.
2. Press  (VOLUME DOWN) once to reduce the volume.
3. Press and hold either  or  and the BlueCube Media Player will increase or decrease audio volume continuously.

## 4.1 Specifications

**Media**  
Supported media.....Bluetooth/MP3  
Device control.....via Bluetooth/MP3 device  
RF Handheld Remote Control or Wired Remote Control (sold separately)

**Inputs**  
Auxiliary.....1x stereo pair RCA input

**Outputs**  
Pre-Out.....1x stereo pair RCA (4V)

**Power**  
Output voltage @ 2 Ohm.....4x 72W  
Output voltage @ 4 Ohm.....4x 45W  
Operation voltage.....9.6V - 14.4V DC  
Max current draw.....7A  
Standby current draw.....6mA

**Multi-Environment Certifications**  
Waterproof / Dustproof.....Yes IP64  
Conformal PCB coating.....Yes  
UV protection.....500 hours stable, ASTM D4329 compliant  
Salt/Fog protection.....500 hours stable, ASTM B117 compliant  
Stainless Steel mountings.....Yes

## 4.2 Dimensions

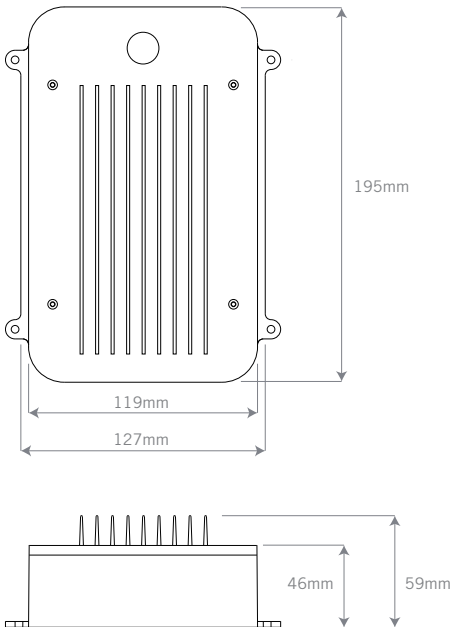



Aquatic AV offers a limited warranty of our products on the following terms:

**Length of warranty**

2 years on audio systems, electronics, speakers, and accessories (receipt required).

**Coverage**

This warranty covers only the original purchaser of a Aquatic AV product purchased from an authorized Aquatic AV dealer in the United States. In order to receive service, the purchaser must provide Aquatic AV with a copy of the receipt stating the customer name, dealer name, product purchased and date of purchase.

**Defective products**

Products found to be defective during the warranty period will be repaired or replaced (with a product deemed to be equivalent) at Aquatic AV's discretion.

**What is not covered**

Damage caused by accident, abuse, improper operations, theft. Any cost or expense related to the removal or reinstallation of product. Service performed by anyone other than an authorized Aquatic AV service center. Any product with the serial number or tamper labels defaced, altered, or removed. Subsequent damage to other components. Any product not purchased from an authorized Aquatic AV dealer.

**Limit on implied warranties**

Any implied warranties including warranties of fitness for use and merchantability are limited in duration to the period of the express warranty set forth above. Some states do not allow limitations on the length of an implied warranty, so this limitation may not apply. No person is authorized to assume for Aquatic AV any other liability in connection with the sale of the product.

**How to obtain service**

You must obtain a return material authorization number (RMA) to return any product to Aquatic AV. You are responsible for shipping charges of returned products to Aquatic AV.

Please record the model and serial number[s] of your equipment in the space provided below as your permanent record and will assist us with your factory warranty coverage. These numbers can be found on the rear of the BlueCube Media Player.

Model number[s]:	Serial number[s]:

FCC ID:  
MADE IN CHINA

This device complies with Part 15 of the FCC Rules. Operation is subject to the following two conditions: (1) this device may not cause harmful interference, and (2) this device must accept any interference received, including interference that may cause undesired operation.

**NOTE:**

The equipment has been tested and found to comply with the limits for a Class B digital device, pursuant to Part 15 of the FCC Rules. These limits are designed to provide reasonable protection against harmful interference in a residential installation. This equipment generates, uses and can radiate radio frequency energy and, if not installed and used in accordance with the instructions, may cause harmful interference to radio communications. However, there is no guarantee that interference will not occur in a particular installation.

If this equipment does cause harmful interference to radio or television reception, which can be determined by turning the equipment off and on, the user is encouraged to try to correct the interference by one or more of the following measures:

- Reorient or relocate the receiving antenna.
- Increase the separation between the equipment and receiver.
- Consult the dealer or an experienced radio/TV technician for help.

The manufacturer is not responsible for any radio or TV interference caused by unauthorized modifications to this equipment. Such modifications could void the user authority to operate the equipment.



**California Proposition  
65 Warning**



**WARNING:** This product contains chemicals known to the State of California to cause cancer, and birth defects or other reproductive harm.

*For more information: [www.P65Warnings.ca.gov](http://www.P65Warnings.ca.gov)*

## **Aquatic AV**

282 Kinney Drive  
San Jose, CA 95112, USA

**E-mail:** [info@aquaticav.com](mailto:info@aquaticav.com)

**US & Canada:** 1 877 579 2782

**International:** +1 408 559 1668

**Fax:** +1 408 559 0125

**[www.aquaticav.com](http://www.aquaticav.com)**

**AQUATIC AV<sup>®</sup>**  
products with a watertight reputation