

AQUATIC AV®

products with a watertight reputation

AQ-DM-5BT - DIGITAL MEDIA LOCKER™

for Bluetooth & MP3 devices

OWNERS MANUAL



! PLEASE READ THIS INSTRUCTION MANUAL BEFORE INSTALLATION AND OPERATION !

1 Getting Started	3
1.1 Contents.....	3
1.2 Connections.....	3
1.3 12-pin Harness Connection.....	4
1.4 Mounting the Digital Media Locker.....	4
1.5 Power On.....	5
1.6 Remote Control Battery Install.....	5
1.7 Remote Control Synchronizing.....	5
2 Location of Controls	6
2.1 Digital Media Locker Controls.....	6
2.2 Door Keypad Controls.....	6
2.3 Remote Control.....	7
3 Listening to Devices	8
3.1 Listening via Bluetooth.....	8
3.1.1 Pair with Bluetooth Device.....	8
3.1.2 Listening via Bluetooth Device.....	8
3.2 Listening via Auxiliary Input.....	8
4 Specifications & Dimensions	9
4.1 Specifications.....	9
4.2 Dimensions.....	9
5 Warranty Information	10

1.1 Contents

- AQ-DM-5BT Digital Media Locker™
- 2-Way RF Waterproof Remote Control, AQ-RFDM-5BT (optional)
- RF Remote Control Receiver (optional)
- Jack Cable (3.5mm Male to 3.5mm Male)
- Wiring Harness (AQ-UNH-2)
- Six (6) Stainless Steel Mounting Screws
- One (1) CR-2450 Remote Control Battery (optional)
- Mounting Template
- Owner's Manual

1.2 Connections

1. 12-pin Watertight Harness

The 12-pin harness supplies power and ground connections to the Digital Media Locker and four (4) speaker channel output connections from the Digital Media Locker.

 *Do not cut or modify the 12-pin harness on the Locker side or warranty will be void.*

2. Auxiliary Outputs

Allows external amplifiers to be connected to power additional speakers.

3. 8-pin DIN Remote Receiver Cable

Connects to the RF Remote Control Receiver (optional).

4. RF Remote Control Receiver (optional)

Allows RF Remote Control signal to be received.

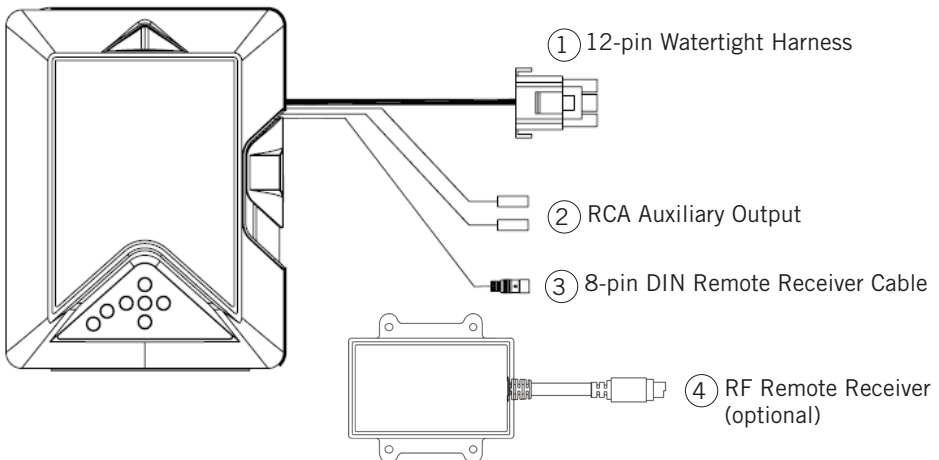

1.3 12-pin Harness Connection

The AQ-DM-5BT includes the universal harness AQ-UNH-2 in order to connect the dock to power and speakers.

All open wire connections should be soldered and protected against water and dust for best long term performance.

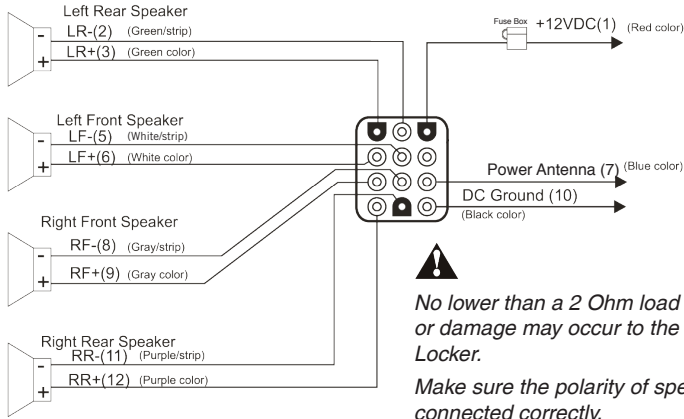

1.4 Mounting the Digital Media Locker

1. A mounting template is included. Aquatic AV recommends using the 'measure twice, cut once' method!
2. Once the mounting hole is complete, make sure the outside surface is clean and clear of debris. The Digital Media Locker has an external water/dust proof gasket, but this requires a clean and flat surface for best performance.
3. The Digital Media Locker has six (6) front screws. Drive the screws using a screw driver. During final mounting apply equal pressure to all points for the best water/dust outer seal performance. Make sure screws are snug and do not over tighten.
4. Review all outside surfaces of the Digital Media Locker to ensure proper water/dust seal. This is important for long term environmental protection performance for your digital media device.

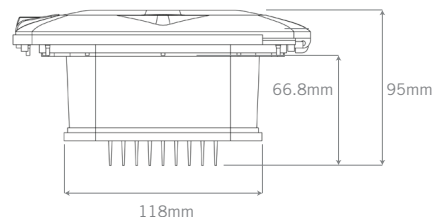
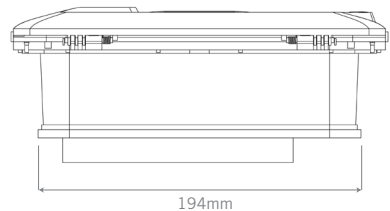

1.5 Power On

Press the  on/off button inside the dock.

Red Light: Power to the docking station is ON, but the unit is in standby mode.

Blue Light: The unit is powered ON and looking for an audio source.



For applications that require low current draw and where battery drain may occur, the power button must be turned OFF inside the unit. When the power button is in the OFF position the red LED will not be lit.

For applications where a 12V battery is not used, such as in a Spa, the power button can be left ON and the remote control or door controls can then be used to power on/off accordingly.

1.6 Remote Control Battery Install for AQ-RFDM-5BT (optional)

Remove the RF wireless remote control from the Digital Media Locker box. Unscrew the waterproof cap on the back of the remote control. Place the CR-2450 battery in the RF remote control and replace the water/dust proof cap.

1.7 Remote Control Synchronizing for AQ-RFDM-5BT (optional)

1. Connect the RF Remote Receiver and 8-pin DIN Remote Receiver Cable together.
2. Turn the Digital Media Locker to OFF mode with the power button inside the door. The LED should not be illuminated.
3. Press the red  (POWER) button on the remote.
4. Press and hold the  (MODE) button until the LCD reads PAIR.
5. Continue to press and hold the  (MODE) button during step 5 below.
6. Turn the docking station to standby mode (within 10 seconds) with the on/off button inside door (the red LED will illuminate and then turn blue).
7. The remote's LCD should read WELCOME and then display mode position BT AUDIO or AUX IN.

For any additional remote controls, you will also need to activate/synchronize those remote controls by following the steps above.

i *If the pairing process is not effective, switch the locker off using the on/off button located inside the door of the dock. Unplug the 12-pin Harness on the back of the Locker for 3 minutes. Reattach the Harness and repeat steps 1-6 above.*

i *If the pairing process is not effective, check the battery voltage. If above 3V DC refer to section 1.5 above top make sure the battery is installed correctly. If battery voltage is below 3V DC replace the battery.*

i *If you lose your remote control and purchase another new remote control, please follow the above to start pairing before normal usage.*

2.1 Digital Media Locker Controls

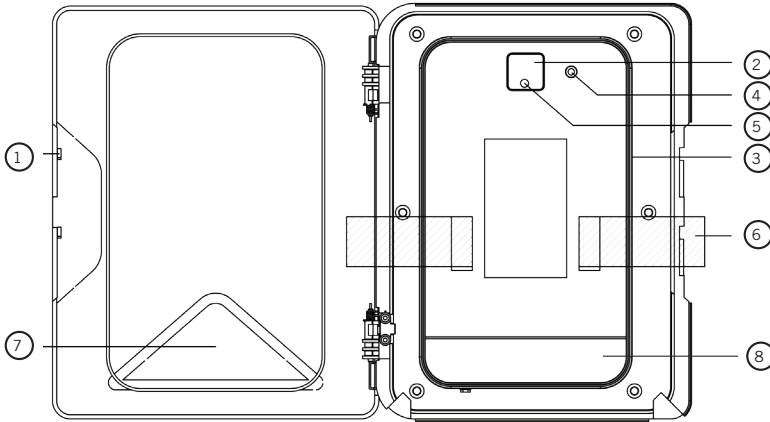

- 1. Open/Close Latch & Protective Door
- 2. Power ON/OFF Button
- 3. Water/Dust Protection Inner Gasket
- 4. 3.5mm Aux Input for MP3 Devices

- 5. Power ON/OFF LED
- 6. Security Strap for digital media devices
- 7. Door Control Keypad
- 8. Cable Storage Tray



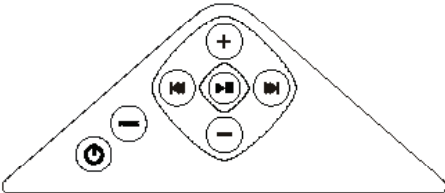



2.2 Door Keypad Controls

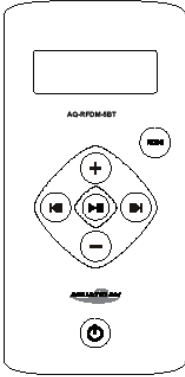

Buttons		MP3 Mode (Aux In)	Bluetooth Mode
Power		Press once: Toggle from Operation mode to Standby mode or vice-versa.	
Mode		Press once: Change the source. Press and hold: No function	Press once: Change the source. Press and hold: No function
Volume Up		Press once: Volume up Press and hold: Fast volume up	Press once: Volume up Press and hold: Fast volume up
Volume Down		Press once: Volume down Press and hold: Fast volume down	Press once: Volume down Press and hold: Fast volume down
Fast Rewind		Press once: No function Press and hold: No function	Press once: Previous Track Press and hold: Previous Track
Fast Forward		Press once: No function Press and hold: No function	Press once: Next Track Press and hold: Next Track
Play/pause		Press once: Toggle mute Press and hold: Toggle mute	Press once: Play/Pause Press and hold: Play/Pause

2.3 Remote Control



Buttons	MP3 Mode (Aux In)	Bluetooth Mode
Power	 Press Once: Turns remote control on. Press Twice: Toggle from Operation mode to Standby mode or vice-versa.	
Mode	 Press once: Change the source. Press and hold: Pair	Press once: Change the source. Press and hold: Pair
Volume Up	 Press once: Volume up Press and hold: Fast volume up	Press once: Volume up Press and hold: Fast volume up
Volume Down	 Press once: Volume down Press and hold: Fast volume down	Press once: Volume down Press and hold: Fast volume down
Play / Pause	 Press once: Toggle Mute Press and hold: Toggle Mute	Press once: Play/Pause Press and hold: Play/Pause
Fast Rewind	 Press once: No function Press and hold: No function	Press once: Previous Track Press and hold: Previous Track
Fast Forward	 Press once: No function Press and hold: No function	Press once: Next Track Press and hold: Next Track

i If your music player is connected via the Auxiliary input you will not be able to control track or receive track information.

i In order to prolong remote battery life the LCD will shut off in 20 seconds if no other button is pressed. To turn remote back on press any key once and then press the command desired.



3.1 Listening via Bluetooth

3.1.1 Pair with Bluetooth Device

1. Switch on your Bluetooth device.
2. Select 'AQUATIC AV' from the list of available devices to pair (no password is needed).

 *Only one Bluetooth device can be paired with the Digital Media Locker at any time.*

3.1.2 Listening via Bluetooth Device

1. Bluetooth mode will be activated once a Bluetooth device is linked.
2. Play the song from device and the sound will play through the Digital Media Locker.
3. Press  (PLAY/PAUSE) to play/pause the song.
4. Press  /  (FAST REWIND/FORWARD) buttons to play previous/next song file.
5. Track and volume can be controlled directly from your Bluetooth device, remote control or door controls.

3.2 Listening via Auxiliary Input

1. Power up the Digital Media Locker.
2. Connect your MP3 device to the 3.5mm Jack input.
3. Secure the device with the anchor straps provided.
4. Secure the Digital Media Locker's protective door.
5. Press  (MODE) on the remote control to select 'AUX IN' mode.

 *Always ensure to connect and disconnect your media player with dry hands!*

4.1 Specifications

Media

Supported media.....Bluetooth/MP3
Supported media max. dimensions.....107 x 184mm (WxH)
Device control.....via Door Controls & optional RF Remote Control

Inputs

Auxiliary.....1x 3.5mm Stereo Jack Socket

Outputs

Pre-Out.....1x Stereo pair RCA (4V)

Power

Output voltage @ 2 Ohm.....4x 72W
Output voltage @ 4 Ohm.....4x 45W
Operation voltage.....9.6V - 14.4V DC
Max current draw.....7A
Standby current draw.....6mA

Multi-Environment Certifications

Waterproof / Dustproof.....Yes IP65 (Remote Control rated IP66)
Conformal PCB coating.....Yes
UV protection.....500 hours stable, ASTM D4329 compliant
Salt/Fog protection.....500 hours stable, ASTM B117 compliant
Stainless Steel mountings.....Yes

4.2 Dimensions

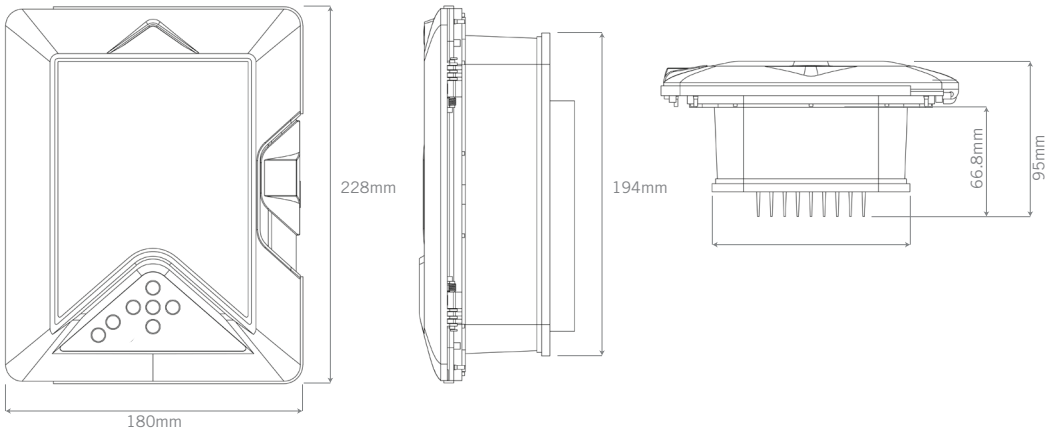

Aquatic AV offers a limited warranty of our products on the following terms:

Length of warranty

2 years on audio systems, electronics, speakers, and accessories (receipt required).

Coverage

This warranty covers only the original purchaser of a Aquatic AV product purchased from an authorized Aquatic AV dealer in the United States. In order to receive service, the purchaser must provide Aquatic AV with a copy of the receipt stating the customer name, dealer name, product purchased and date of purchase.

Defective products

Products found to be defective during the warranty period will be repaired or replaced (with a product deemed to be equivalent) at Aquatic AV's discretion.

What is not covered

Damage caused by accident, abuse, improper operations, theft. Any cost or expense related to the removal or reinstallation of product. Service performed by anyone other than an authorized Aquatic AV service center. Any product with the serial number or tamper labels defaced, altered, or removed. Subsequent damage to other components. Any product not purchased from an authorized Aquatic AV dealer.

Limit on implied warranties

Any implied warranties including warranties of fitness for use and merchantability are limited in duration to the period of the express warranty set forth above. Some states do not allow limitations on the length of an implied warranty, so this limitation may not apply. No person is authorized to assume for Aquatic AV any other liability in connection with the sale of the product.

How to obtain service

You must obtain a return material authorization number (RMA) to return any product to Aquatic AV. You are responsible for shipping charges of returned products to Aquatic AV.

Please record the model and serial number[s] of your equipment in the space provided below as your permanent record and will assist us with your factory warranty coverage. These numbers can be found on the rear of the Digital Media Locker.

Model number[s]:	Serial number[s]:

FCC ID:
MADE IN CHINA

This device complies with Part 15 of the FCC Rules. Operation is subject to the following two conditions: (1) this device may not cause harmful interference, and (2) this device must accept any interference received, including interference that may cause undesired operation.

NOTE:

The equipment has been tested and found to comply with the limits for a Class B digital device, pursuant to Part 15 of the FCC Rules. These limits are designed to provide reasonable protection against harmful interference in a residential installation. This equipment generates, uses and can radiate radio frequency energy and, if not installed and used in accordance with the instructions, may cause harmful interference to radio communications. However, there is no guarantee that interference will not occur in a particular installation.

If this equipment does cause harmful interference to radio or television reception, which can be determined by turning the equipment off and on, the user is encouraged to try to correct the interference by one or more of the following measures:

- Reorient or relocate the receiving antenna.
- Increase the separation between the equipment and receiver.
- Consult the dealer or an experienced radio/TV technician for help.

The manufacturer is not responsible for any radio or TV interference caused by unauthorized modifications to this equipment. Such modifications could void the user authority to operate the equipment.



**California Proposition
65 Warning**



WARNING: This product contains chemicals known to the State of California to cause cancer, and birth defects or other reproductive harm.

For more information: www.P65Warnings.ca.gov

Patent: 8,578,081

Digital Media Locker is a trademark of Aquatic AV Inc.

Product design and specification subject to change without notice. E&OE.

Doc V2.2



Aquatic AV

282 Kinney Drive
San Jose, CA 95112, USA

E-mail: info@aquaticav.com

US & Canada: 1 877 579 2782

International: +1 408 559 1668

Fax: +1 408 559 0125

www.aquaticav.com

AQUATIC AV[®]
products with a watertight reputation